

VERSIONE IN MARCIA

VERSIONE GIORNO

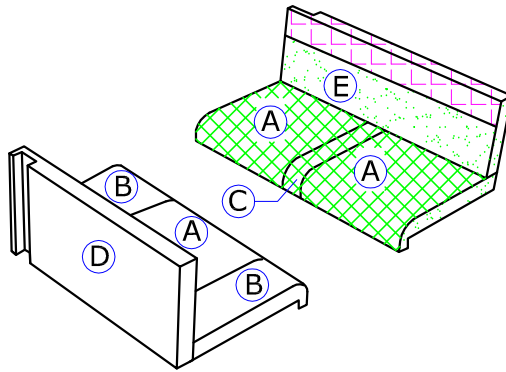

LEGENDA	
TIPO	TESSUTO
	Vermentino col.01 trapuntato1047
	Vermentino col.01 liscio
	Vermentino rosso col.10
	Vermentino marrone col.622

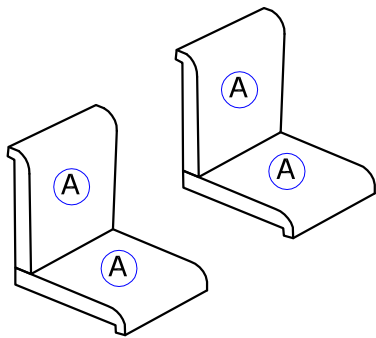
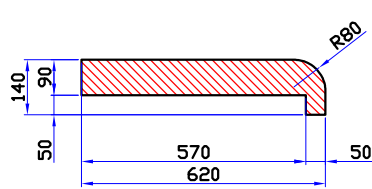
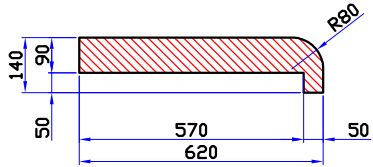

Vestitino per
spalliera
struttura
cinture

Q.ta n°2

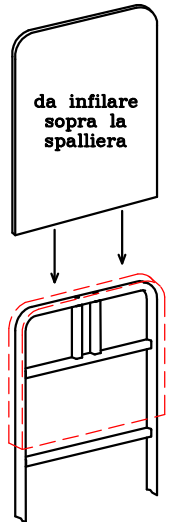
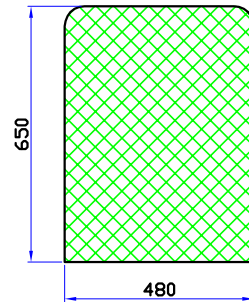
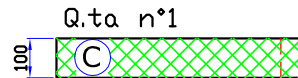
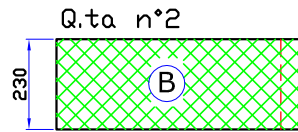
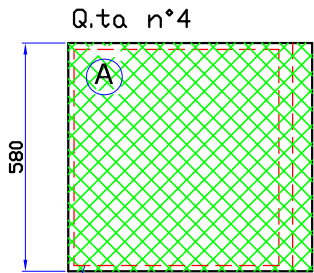

Inserire tavola

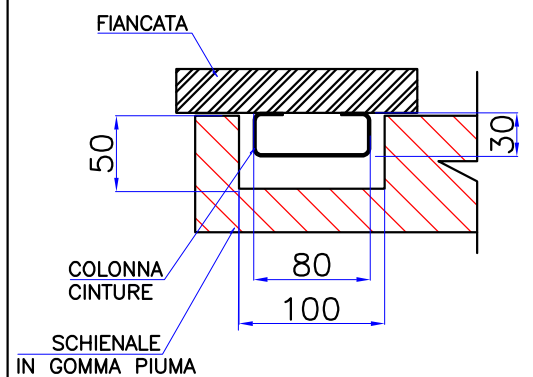
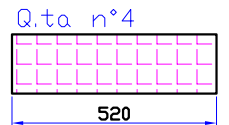
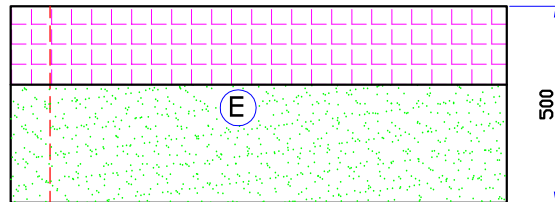
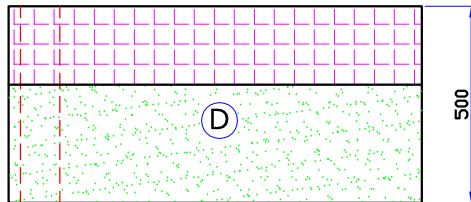
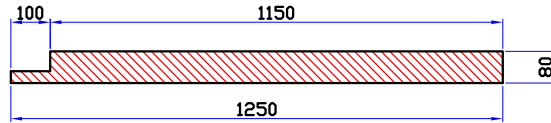
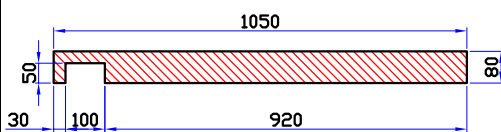

LCAMP

SEDE Via Piemonte n°3
53036 Poggibonsi SIENA ITALY

Denominazione			Cuscini Seal 66
Caratteristiche	SCHIENALI-POGGIATESTA Densita' 21 Kg/m ³		Codice
gommapiuma	SEDUTE-MATERASSI Densita' 25 Kg/m ³		
Produzione	Meccanica	NOTE	Le dimensioni sono riferite al cuscino finito
2019-2020	FIAT		

Codice		1TAP090637
Codice lavorazione		---
Rev	Data	
02	13-01-2020	

TOLLERANZE DI MASSIMA Grado di precisione medio UNI 5307	PAG 1 di 1
Disegnato A.PINZUTI	Data 27-02-2019
Approvato A.PINZUTI	Data 27-02-2019

02	Eliminato stoffa copricolonna	13-01-2020	A.PINZUTI
01	Modificato cuscino A e cuscino cilindrico	11-12-2019	A.PINZUTI
Rev	MODIFICA	DATA	ESEGUITA

I dati e le informazioni contenuti o ricavabili da questo disegno sono di esclusiva proprietà della Luano Camp S.r.l. Ogni riproduzione totale o parziale e' vietata senza l'autorizzazione scritta della ditta Luano Camp S.r.l.

